

Kepeco gives you the power to ride the rails.



Kepeco DIN-Rail Mounting Kits.

DIN-Rail mounting is a fast, easy way to attach a variety of power supplies to a standard DIN-Rail, freeing up valuable space for equipment which require panel exposure for control and display. DIN-Rails are used worldwide in many applications, especially in industrial control systems. Kepeco's DIN-Rail kits provide the mounting hardware and clips that allow easy mounting and dismounting of power modules in a variety of orientations.

Smaller modules may be clipped onto the DIN-Rail in the long and short orientations and may also be mounted perpendicularly. The

figures on the back illustrate these mounting options. Larger power modules are limited to long and short or long-only DIN-Rail mounting. The charts list the kits and mounting orientations which are presently offered. The kits include enclosures for normally open construction PC card and L-chassis power supplies. Models which use input/output connectors instead of barrier strips, have mating connectors with 3' pigtail leads included in their DIN-Rail mounting kits.

Selected models have UL 508 listing in addition to UL 1950. Please consult the factory for information about UL 508 listings.

For the full specifications on Kepeco's modular power supplies, please see Kepeco's printed catalog 146-1862 or Kepeco's on-line catalog at www.kepecopower.com. Kepeco's DIN-Rail mounting kits are a simple, low-cost solution to many installation problems.

COME, RIDE THE RAILS WITH US.

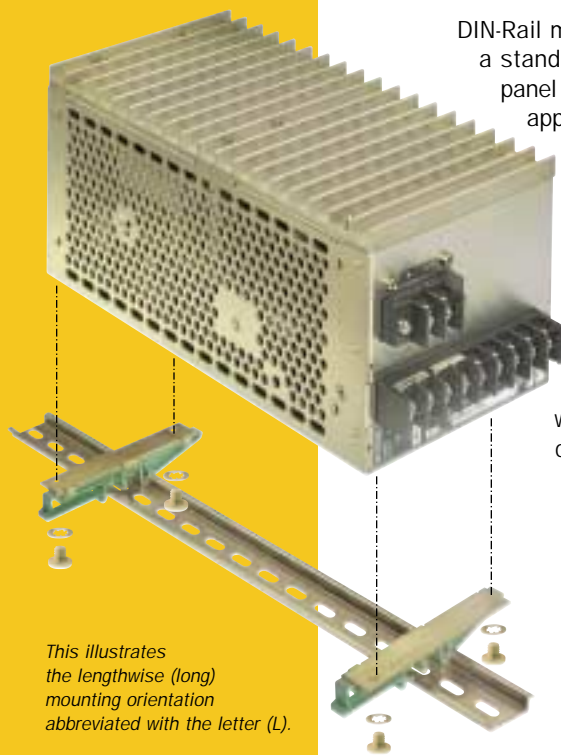

This illustrates the lengthwise (long) mounting orientation abbreviated with the letter (L).

SEE
OTHER
SIDE
FOR
UL 508
MODELS



Kepeco, Inc., 131-38 Sanford Avenue, Flushing, NY 11352 USA
Tel: (718) 461-7000 • Fax: (718) 767-1102 • E-Mail: hq@kepecopower.com • www.kepecopower.com

THE POWER TO MAKE IT WORK.™

Kepeco DIN-Rail Kits Will Put You On The Right Track.

DIN-Rail

Long Orientation

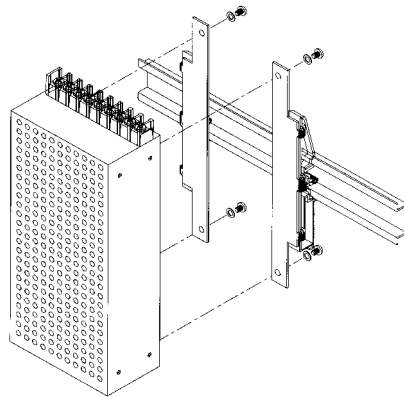
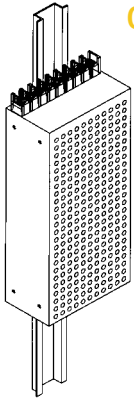

The DIN-Rail clips mount to the power module's tapped mounting holes and clip directly to a DIN-Rail. The orientation illustrated is the short (S) mounting.

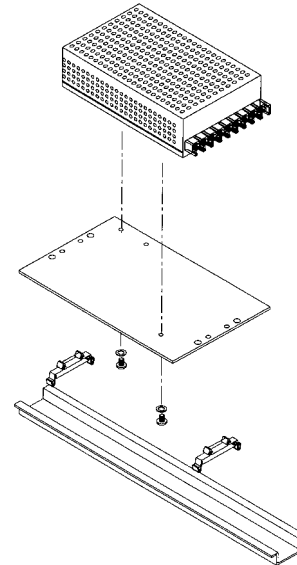

Mini clips are used to mount lighter power supplies to the DIN-Rail. As illustrated, adapter plates are used to pick up the power module's tapped mounting holes.

DIN-Rail

Short Orientation

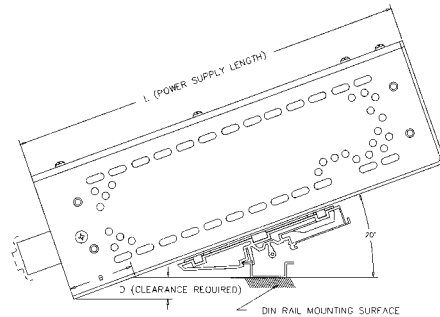
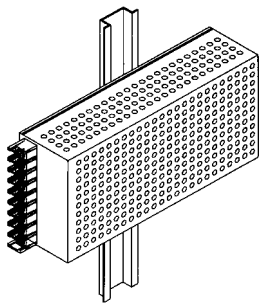

When power modules are mounted in the short direction, special consideration must be given to provide sufficient clearance as illustrated, to allow the module to be rotated as the DIN-Rail clips engage.

DIN-Rail

Perpendicular Orientation

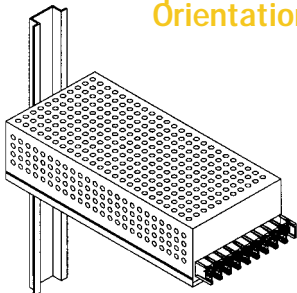

Single-output a-c to d-c models

Group	3/10W	15W	25/30W	50W	100W	150/175W	300/350W	600W	750W	1000W	1500W
FAK		SLP	SLP	SLP							
FAW		SLP	SLP	SLP	SLP	SLP					
FMP	SLP										
HSM										L	L
RAX				SLP	SLP	SLP	SLP				
RCW							SL		L		
RKW			SLP	SLP	SLP	SLP	SLP	LP			L

▲ FAW Models and RCW 350W Models are UL 508 listed. For more information, consult the factory.

Multi-output a-c to d-c models

Group	3/10W	35/40W	50W	65W
FCP	SLP			
KRW		SLP		
MRW		SLP	SLP	SLP

Single-output d-c to d-c converters

Group	30W	60W	150W
ERD	SLP	SLP	SLP

Programmable a-c to d-c models

Group	20W	50W
PAT	SL	
PTR		SL

S=Short L=Long P=Perpendicular Orientations as illustrated in the drawings to the left.



Kepeco, Inc., 131-38 Sanford Avenue, Flushing, NY 11352 USA
Tel: (718) 461-7000 • Fax: (718) 767-1102 • E-Mail: hq@kepcopower.com • www.kepcopower.com